



QVE00033 Phototransistor Optical Surface Mount Interrupter Switch

Features

- No contact switching
- Transistor Output
- Compact surface mount package
- Opaque black plastic housing
- 2mm wide slot
- 0.4 mm aperture width
- Tape and reel
- Reflow conditions:
 - Preheat = 160°C for 120 seconds
 - Reflow = 200°C for 60 seconds (peak = 240°C)
- HL-94V-0 housing

Description

The QVE00033 is a miniature slotted optical switch designed for surface mount applications. It consists of a GaAs LED and a silicon phototransistor facing each other across a 2mm gap, and packaged in a temperature resistant black plastic housing.

Package Dimension

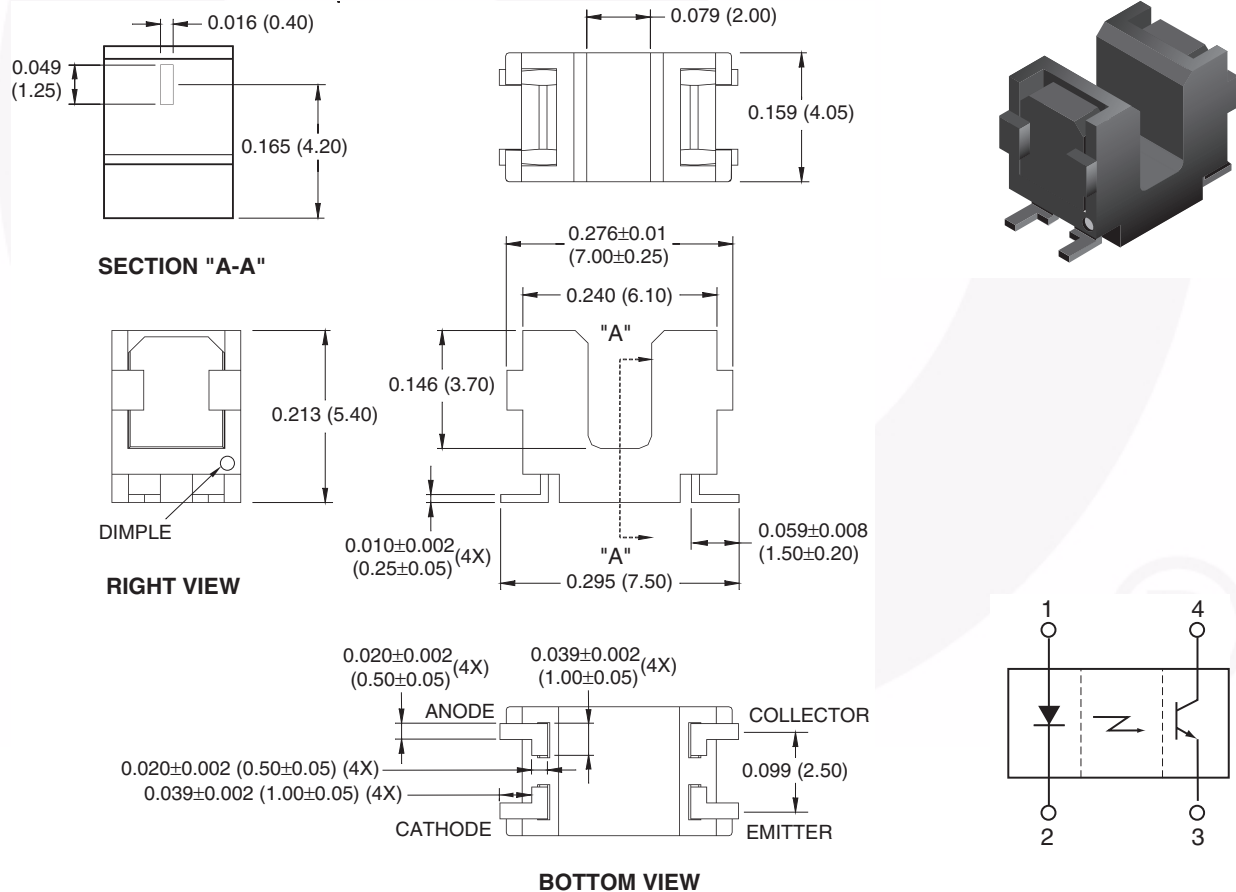

Note:

1. Dimensions for all drawings are in inches (millimeters). Tolerance ±0.005" (0.127mm) unless otherwise specified.

Absolute Maximum Ratings ($T_A = 25^\circ\text{C}$ unless otherwise specified)

Stresses exceeding the absolute maximum ratings may damage the device. The device may not function or be operable above the recommended operating conditions and stressing the parts to these levels is not recommended. In addition, extended exposure to stresses above the recommended operating conditions may affect device reliability. The absolute maximum ratings are stress ratings only.

Symbol	Parameter	Rating	Units
T_{OPR}	Operating Temperature	-55 to +100	$^\circ\text{C}$
T_{STG}	Storage Temperature	-55 to +100	$^\circ\text{C}$
$T_{\text{SOL-I}}$	Soldering Temperature (Iron) ^(2,3,4)	240 for 5 sec.	$^\circ\text{C}$
$T_{\text{SOL-F}}$	Soldering Temperature (Flow) ^(2,3)	260 for 10 sec.	$^\circ\text{C}$
P_{TOT}	Total Power Dissipation	100	mW
EMITTER			
I_F	Continuous Forward Current	50	mA
V_R	Reverse Voltage	6	V
P_D	Power Dissipation ⁽¹⁾	75	mW
SENSOR			
V_{CEO}	Collector-Emitter Voltage	30	V
V_{ECO}	Emitter-Collector Voltage	4.5	V
I_C	Collector Current	20	mA
P_D	Power Dissipation ⁽¹⁾	75	mW

Notes:

1. Derate power dissipation linearly 1.00mW/ $^\circ\text{C}$ above 25 $^\circ\text{C}$.
2. RMA flux is recommended.
3. Methanol or isopropyl alcohols are recommended as cleaning agents.
4. Soldering iron tip 1/16" (1.6mm) from housing.

Electrical/Optical Characteristics ($T_A = 25^\circ\text{C}$ unless otherwise specified)

Symbol	Parameter	Test Conditions	Min.	Typ.	Max.	Units
EMITTER						
V_F	Forward Voltage	$I_F = 20\text{mA}$		1.2	1.4	V
I_R	Reverse Current	$V_R = 4\text{V}$			10	μA
λ_{PE}	Peak Emission Wavelength	$I_F = 20\text{mA}$		940		nm
SENSOR						
I_{CEO}	Dark Current	$V_{\text{CE}} = 20\text{V}, I_F = 0\text{mA}$			100	nA
COUPLED						
$I_{\text{C(ON)}}$	Collector Current	$I_F = 5\text{mA}, V_{\text{CE}} = 5\text{V}$	100		600	μA
$V_{\text{CE (SAT)}}$	Collector Emitter	$I_F = 10\text{mA}, I_C = 40\mu\text{A}$			0.4	V
t_r	Rise Time	$V_{\text{CC}} = 5\text{V}, R_L = 1000\Omega,$		7	150	μs
t_f	Fall Time	$I_C = 100\mu\text{A}$		7	150	μs

Typical Performance Characteristics

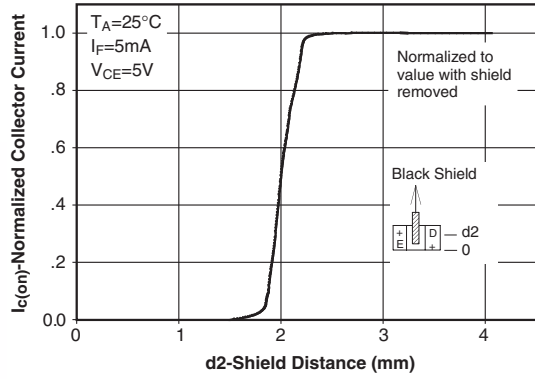

Figure 1. Normalized Collector Current Vs. Shield Distance

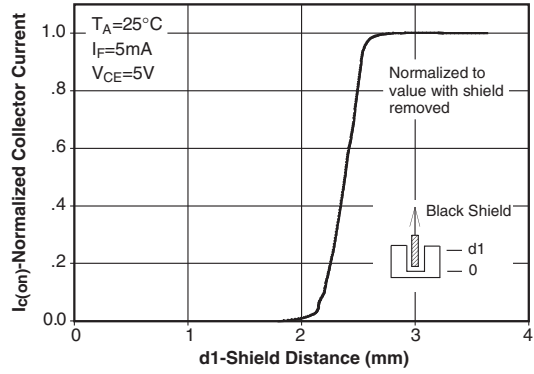

Figure 2. Normalized Collector Current Vs. Shield Distance

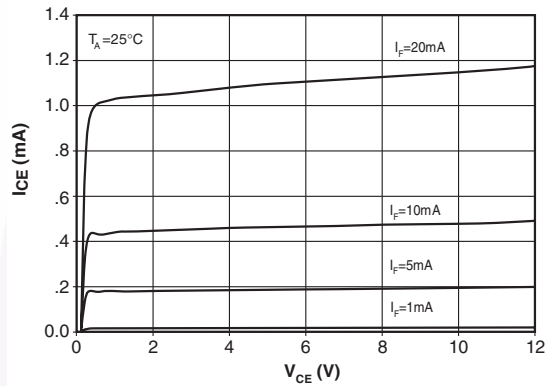

Figure 3. Collector Current Vs. Collector-Emitter Voltage

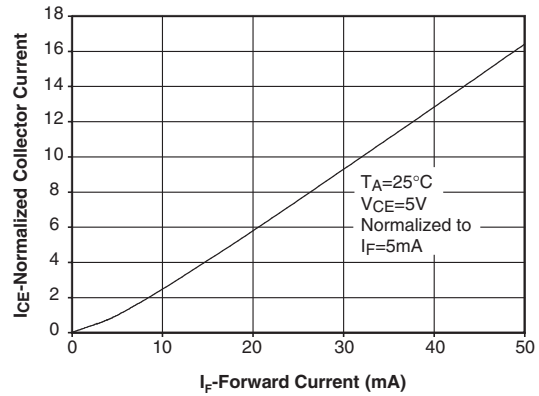

Figure 4. Normalized Collector Current Vs. Forward Current

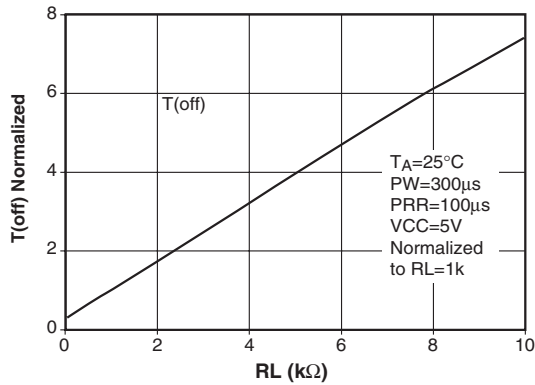

Figure 5. Rise Time vs. Load Resistance

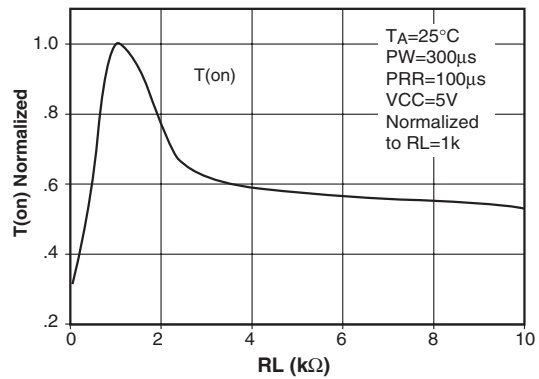
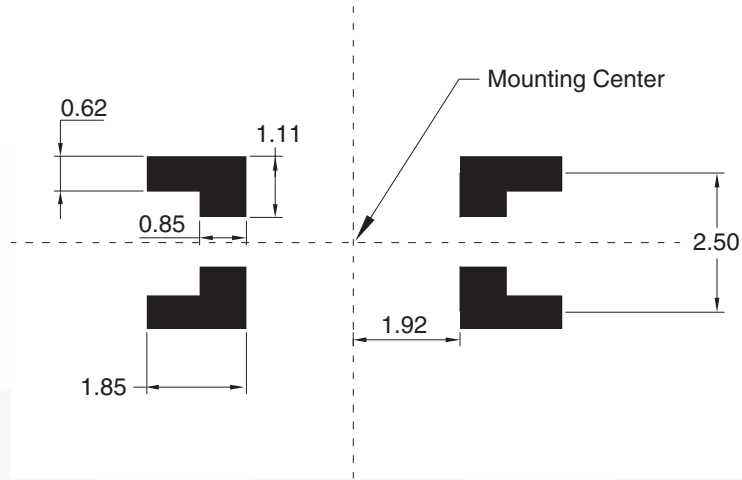
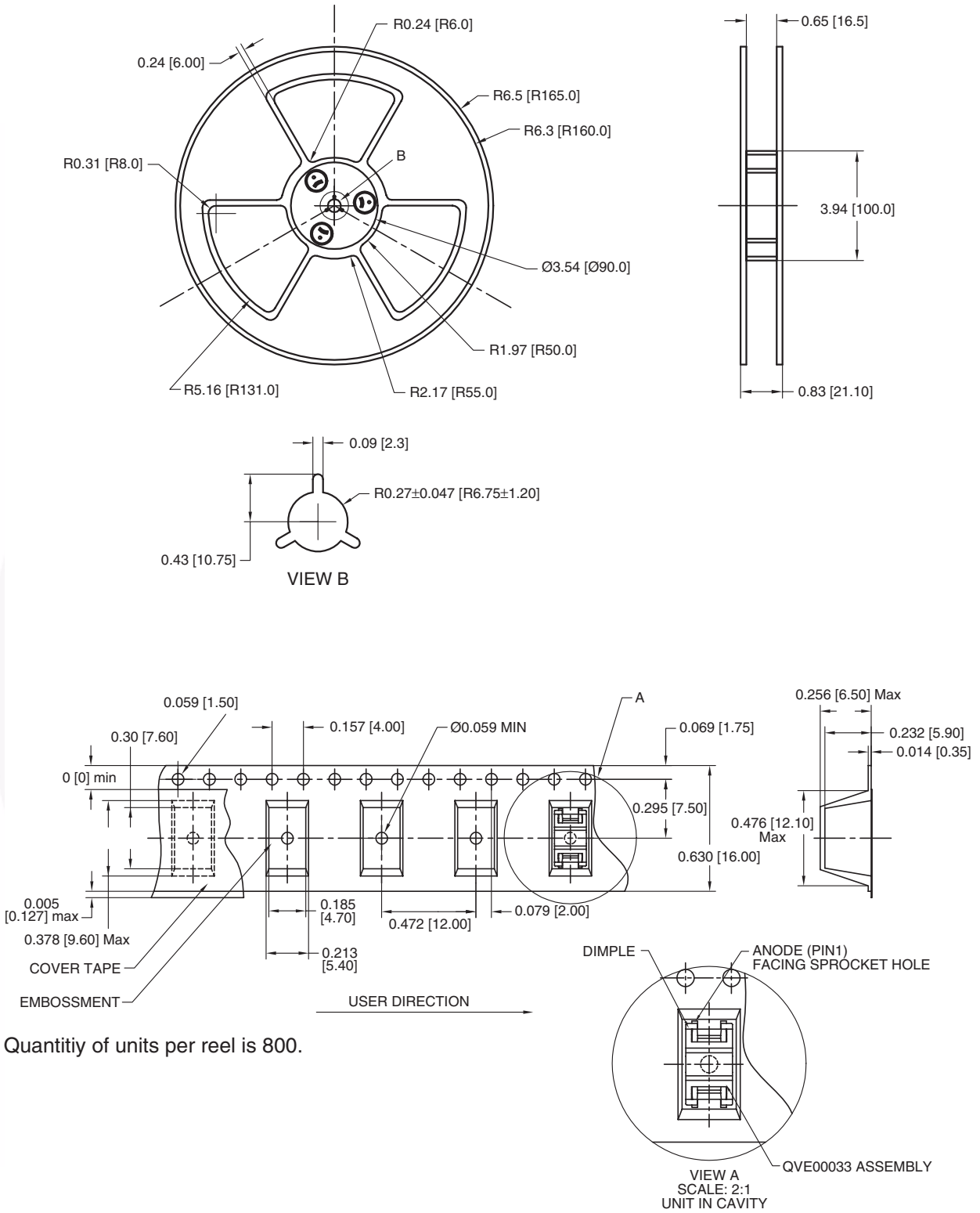

Figure 6. Fall Time vs. Load Resistance

Recommended Printed Circuit Board Pattern (For Reference Only)





Tape and Reel Dimensions





TRADEMARKS

The following includes registered and unregistered trademarks and service marks, owned by Fairchild Semiconductor and/or its global subsidiaries, and is not intended to be an exhaustive list of all such trademarks.

ACEx [®]	FPST [™]	PDP-SPM [™]	SyncFET [™]
Build it Now [™]	FRFET [®]	Power220 [®]	SYSTEM [®]
CorePLUS [™]	Global Power Resource SM	Power247 [®]	GENERAL [®]
CROSSVOLT [™]	Green FPS [™]	POWEREDGE [®]	The Power Franchise [®]
CTL [™]	Green FPS [™] e-Series [™]	Power-SPM [™]	the power [™]
Current Transfer Logic [™]	GTO [™]	PowerTrench [®]	franchise
EcoSPARK [®]	i-Lo [™]	Programmable Active Droop [™]	TinyBoost [™]
EZSWITCH [™] *	IntelliMAX [™]	QFET [®]	TinyBuck [™]
 ™	ISOPLANAR [™]	QS [™]	TinyLogic [®]
 ™	MegaBuck [™]	QT Optoelectronics [™]	TINYOPTO [™]
Fairchild [®]	MICROCOUPLER [™]	Quiet Series [™]	TinyPower [™]
Fairchild Semiconductor [®]	MicroFET [™]	RapidConfigure [™]	TinyPWM [™]
FACT Quiet Series [™]	MicroPak [™]	SMART START [™]	TinyWire [™]
FACT [®]	MillerDrive [™]	SPM [®]	SerDes [™]
FAST [®]	Motion-SPM [™]	STEALTH [™]	UHC [®]
FastvCore [™] *	OPTOLOGIC [®]	SuperFET [™]	Ultra FRFET [™]
FlashWriter [®] *	OPTOPLANAR [®]	SuperSOT [™] -3	UniFET [™]
		SuperSOT [™] -6	VCX [™]
		SuperSOT [™] -8	

* EZSWITCH[™] and FlashWriter[®] are trademarks of System General Corporation, used under license by Fairchild Semiconductor.

DISCLAIMER

FAIRCHILD SEMICONDUCTOR RESERVES THE RIGHT TO MAKE CHANGES WITHOUT FURTHER NOTICE TO ANY PRODUCTS HEREIN TO IMPROVE RELIABILITY, FUNCTION, OR DESIGN. FAIRCHILD DOES NOT ASSUME ANY LIABILITY ARISING OUT OF THE APPLICATION OR USE OF ANY PRODUCT OR CIRCUIT DESCRIBED HEREIN; NEITHER DOES IT CONVEY ANY LICENSE UNDER ITS PATENT RIGHTS, NOR THE RIGHTS OF OTHERS. THESE SPECIFICATIONS DO NOT EXPAND THE TERMS OF FAIRCHILD'S WORLDWIDE TERMS AND CONDITIONS, SPECIFICALLY THE WARRANTY THEREIN, WHICH COVERS THESE PRODUCTS.

LIFE SUPPORT POLICY

FAIRCHILD'S PRODUCTS ARE NOT AUTHORIZED FOR USE AS CRITICAL COMPONENTS IN LIFE SUPPORT DEVICES OR SYSTEMS WITHOUT THE EXPRESS WRITTEN APPROVAL OF FAIRCHILD SEMICONDUCTOR CORPORATION.

As used herein:

1. Life support devices or systems are devices or systems which, (a) are intended for surgical implant into the body or (b) support or sustain life, and (c) whose failure to perform when properly used in accordance with instructions for use provided in the labeling, can be reasonably expected to result in a significant injury of the user.
2. A critical component in any component of a life support, device, or system whose failure to perform can be reasonably expected to cause the failure of the life support device or system, or to affect its safety or effectiveness.

PRODUCT STATUS DEFINITIONS

Definition of Terms

Datasheet Identification	Product Status	Definition
Advance Information	Formative or In Design	This datasheet contains the design specifications for product development. Specifications may change in any manner without notice.
Preliminary	First Production	This datasheet contains preliminary data; supplementary data will be published at a later date. Fairchild Semiconductor reserves the right to make changes at any time without notice to improve design.
No Identification Needed	Full Production	This datasheet contains final specifications. Fairchild Semiconductor reserves the right to make changes at any time without notice to improve the design.
Obsolete	Not In Production	This datasheet contains specifications on a product that has been discontinued by Fairchild Semiconductor. The datasheet is printed for reference information only.

Rev. I32